



PVC SLATWALL



premiumvinylco.com



info@premiumvinylco.com



+1 (310) 537 9270



3116 E Via Mondo,
Compton, CA, 90221



Versatile

Its modular design makes it adaptable to any space or storage need. It can be installed on an entire wall, in sections, or even in corners.



Easy Installation

Our slotted panel can be easily cut to size with an electric saw.

To install, simply screw it directly onto the wall or onto frames. Each piece has an interlocking design. Start from the bottom and securely connect one piece to another.



Easy to Clean

Simply wipe with a damp cloth to remove dirt, marks, or stains.



High Durability

Our PVC Slotted Panel is formulated with a rich blend of additives. It won't crack, and the color will not fade or wear over time. The color is uniform throughout the material, making scratches less noticeable.



Water and Moisture Resistant

By nature, PVC is water-resistant. Our PVC Slotted Panel can be rinsed with a water hose and installed in humid environments, including coastal areas.

Unlike particleboard (MDF) panels, ours do not absorb moisture, will not rot, rust, disintegrate, or fall apart.



Prevents the Spread of Pests, mold, fungus, or bacteria.



Self-Extinguishing

PVC is a fire-retardant material that prevents the spread of flames.



Environmentally Friendly

It is also made with 7% recycled material.



PREMIUM
SAY GOODBYE TO CLUTTER

Organize your garage, basement, mudroom, craft room, playroom, laundry room, home gym, kitchen, retail store, store display, workshop, office, restaurant, factory... You name it.

PVC SLATWALL

Modular system for storage, organization and display solutions.

Our PVC Slatwalls are perfect for either retail stores, homes or workspaces. Its modular design makes it simple to install and to be reconfigured at any time. It can be easily cut to size and arranged to fit any space and storage needs.

It's compatible with accessories from any standard slatwall hanging system with 3" slats: hooks, bins, baskets, shelves, brackets, tool holders, racks, and many more.

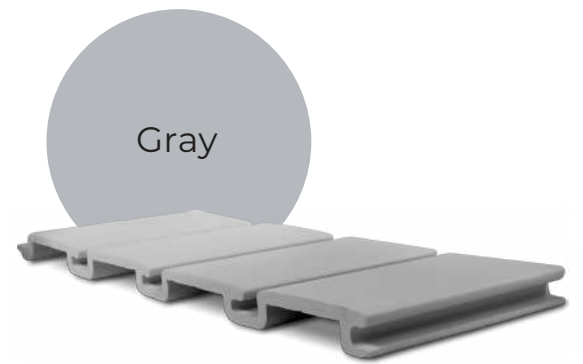

Dimensions

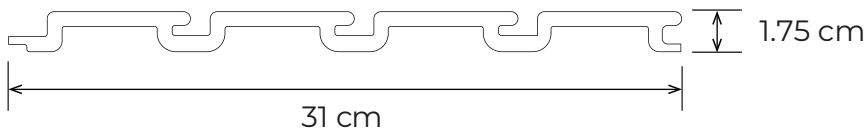

Length: 2.44 m
Standard Weight: 1.650 kg/m

Composition

Component	%
PVC	82%
Calcium Carbonate	5%
Additive	13%
Plasticizer	0%

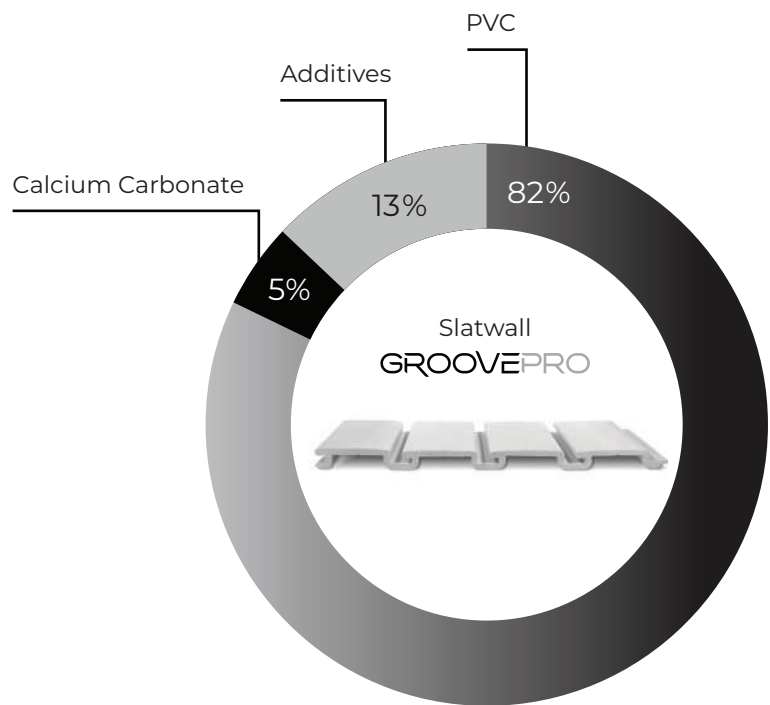

Packaging

Pieces per Box	Product Dimensions	m2 per Package	Package Dimensions	Package Weight
4	31cm x 1.75cm x 2.44m (12 3/4" x 11/16" x 8')	2.97m2 (32ft)	33cm x 8cm x 2.48m	17Kg



Product Specifications

Features	Test Method	Method Description	Result	Unit
Density	ASTM-D-792-2013	Density and Specific Gravity in Plastic by Displacement Method A, Sections 8 to 14.	0.876	g / cm ³
Specific Gravity	ASTM-D-792-2013	Density and Specific Gravity in Plastics by Displacement Method A, Sections 8 to 14.	0.878	
Izod Impact Resistance	ASTM-D-256-18	Standard Test Method for Determining the Impact Resistance of Plastics.	32.2	J / m
Flexural Strength	ASTM-D-790-17	Standard Test Method for Determining the Flexural Properties of Unreinforced Plastic Materials	34.2	Mpa
Flexural Modulus	ASTM-D-790-17	Standard Test Method for Determining the Flexural Properties of Unreinforced Plastic Materials	1,761	Mpa
Thermal Expansion	ASTM-E-831-14	Standard Test Method for Linear Thermal Expansion of Solid Materials by Thermomechanical Analysis	80.74	um / (m°C)
Water Absorption	ASTM-D-570-98/2018	Standard Test Method for Water Absorption of Plastics	0.6	% Incr. Weight 24 h
Water Absorption	ASTM-D-570-98/2018	Standard Test Method for Water Absorption of Plastics	1.5	% Incr. Weight 72 h
Water Absorption	ASTM-D-570-98/2018	Standard Test Method for Water Absorption of Plastics	2.4	% Incr. Weight 120 h
Lead Content	AA/ICP	Heavy Metal Content	Not Detected	
Phthalate and Plasticizer Content	GC/MS	Determination of Phthalates and Plasticizers by Gas Chromatography	Not Detected	
Formaldehyde Content	GC/MS	Determination of Formaldehyde by Gas Chromatography	Not Detected	
Bisphenol Content	GC/MS	Determination of Bisphenol by Gas Chromatography	Not Detected	

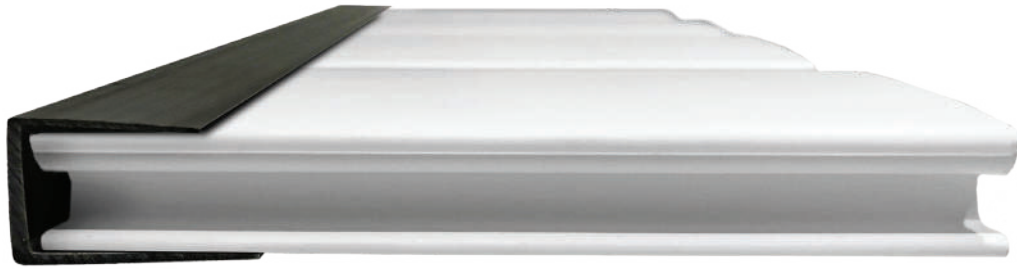

Dimensions

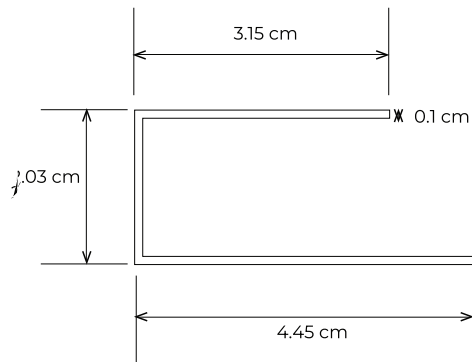

Length: 4 m

Standard Weight: 185 g/m linear meter

Color Variety



White



Ivory

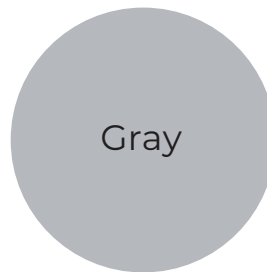

Gray

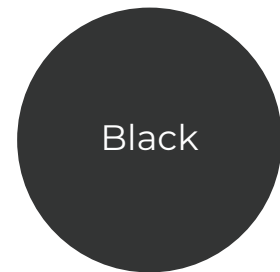

Black



PREMIUM



premiumvinylco.com



info@premiumvinylco.com



+1 (310) 537 9270



3116 E Via Mondo,
Compton, CA, 90221